

Solid

Examples of solids at room temperature are...

...iron, plastic and wood



Which diagram shows the particle arrangement of lava?

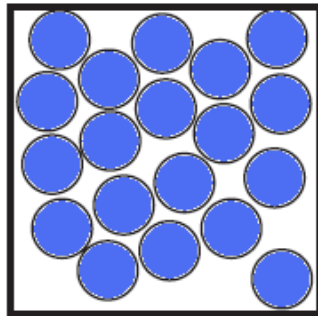
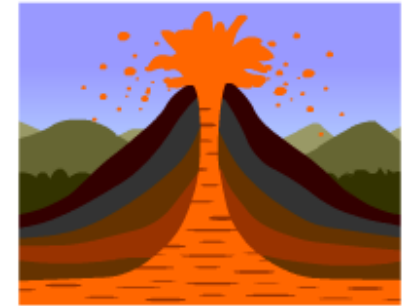

Less than 100ml of liquid

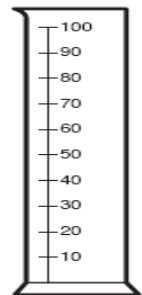

50ml of water + 50ml of alcohol =

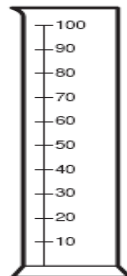
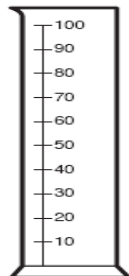

End

...steam



...milk, mercury
and water



Examples of liquids at room
temperature are...

Which diagram shows
the particle
arrangement of gold?

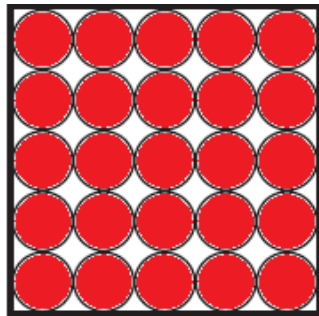
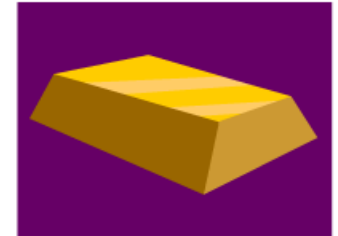

50ml of water + 50ml of water =

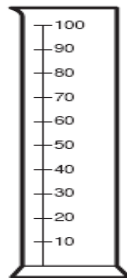
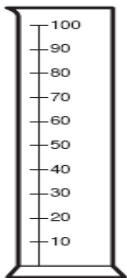

100ml of liquid

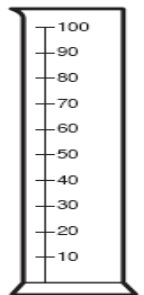

Which state has a fixed shape;
solid, liquid or gas?

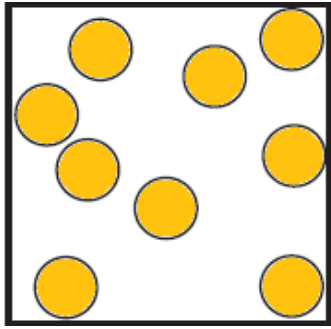

Examples of gases at room temperature are...

...helium, oxygen and carbon dioxide



Which state can be squeezed; solid, liquid or gas?

Gas

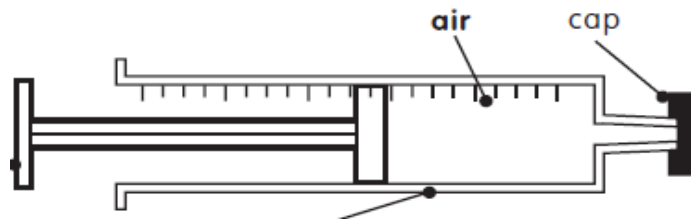

The chemical elements found in water are...

...hydrogen and oxygen
(H₂O)



Water in a gas state is called...

Start

When metals are heated they...

...expand

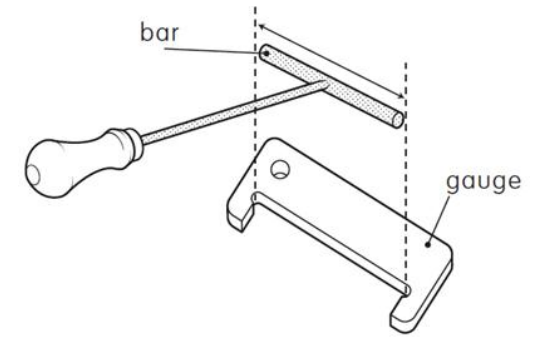

Liquids and gases can flow so they are called...

...fluids



Water in a solid state is called...

...ice

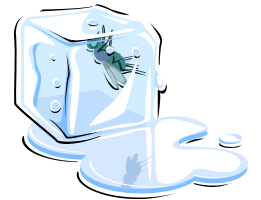

Which diagram shows the particle arrangement of oxygen?

